

N68000 Series High Power DC Electronic Load

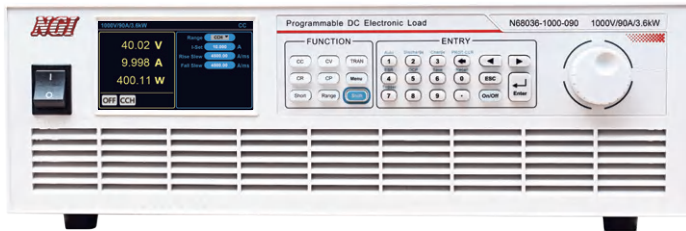

Product Introduction

N68000 series is developed based on NGI's years of experience in testing for power supply, car charger, battery and supercapacitor. It is with high accuracy, high reliability and high cost performance. It has CC, CV, CP and CR mode. N68000 series supports SEQ test, dynamic test, charge test, discharge test, OCP test, etc. The power range covers from 2.4kW to 14.4kW.

Application Fields

- ▶ Charging station, car charger
- ▶ DC-DC power supply, server power supply
- ▶ Communication power supply capacitor module, battery pack
- ▶ High current relay
- ▶ Energy storage system



Main Features

- ▶ Power range: 2.4kW to 14.4kW
- ▶ Voltage range: 150V/600V/1000V
- ▶ Operation modes: CC/CV/CR/CP
- ▶ High power density, minimizing space occupation
- ▶ Transient over-power loading capability
- ▶ Programmable sequence test function(SEQ), up to 100 groups sequence files, up to 50 steps per file
- ▶ Comprehensive MOS protection
- ▶ Multiple protection: OCP, OVP, OTP, OPP and reverse polarity warning
- ▶ Analog programming interface(APG), current monitoring interface, and remote/local trigger function
- ▶ Multiple communication interfaces: LAN/RS232/CAN
- ▶ CR/CP function supported by hardware
- ▶ Charge test, Discharge test and OCP test
- ▶ Built-in ESR test function(Optional)
- ▶ Editable rise and fall slew rate
- ▶ Editable Von/Voff

High reliability design

- N68000 series has a comprehensive MOS protection circuit. No matter how much MOS is damaged, it will not cause short-circuit between the positive and negative polarity or the positive polarity and the control circuit. The damage of some MOSs does not accelerate the damage of others, which can be used continuously.

- By distributed design, it is easy to replace or add power modules and is convenient for maintenance and power expansion.
- N68000 is designed with power limit circuit and has fast response, which can prevent the load from being damaged due to over power.
- N68000 adopts shielding technology, which has wide adaptability to harsh test environment, and improves the anti-interference ability.

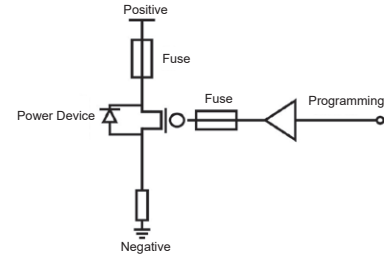

Short-circuit function

N68000 series supports two modes for short circuit: manual and lock.

Manual: N68000 will be short-circuited when Short button is pressed. It will stop short-circuiting when button is released. Manual mode is suitable for debugging or R&D, avoiding measurement accidents due to misoperation.

Lock: N68000 will keep short-circuiting when Short button is pressed. It will stop short-circuiting when the button is pressed again. Lock mode is suitable for long-time short-circuit test.

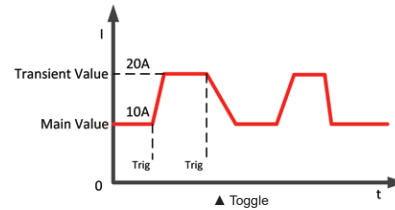
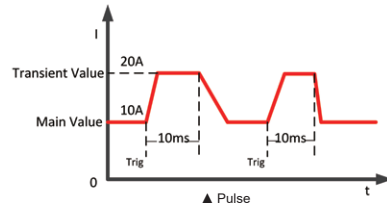
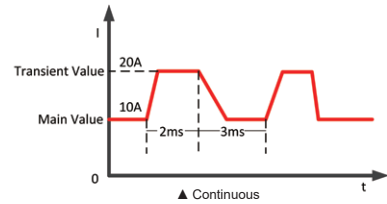

Dynamic mode

N68000 series provides three options for dynamic: continuous, toggle and pulse. The dynamic rate is up to 20kHz and can be adjustable. This function is often used to test power supply transient performance, battery protection board protection performance and battery pulse charging.

Transient over-power loading capability

In transient high power applications, users do not need to select models according to the Max. power. Take DC motor start-up simulation for example. The transient power at start-up is usually several times of the rated power. It can also test the transient overload performance of power supplies and the transient high-power discharge of power batteries.

External programming

Users can control load voltage and current via external analog input. 0-10V input through the external programming interface corresponds to 0-full scale output on the load.

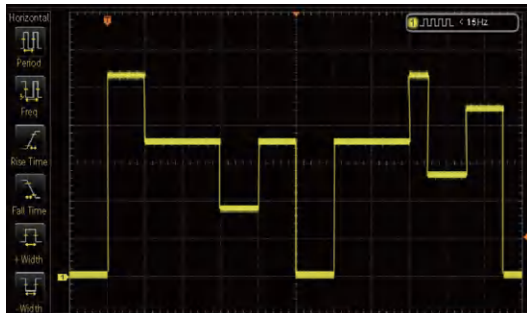

Current monitoring

0-10V analog output at the current monitoring output terminal corresponds to 0-full scale current. Users can use a voltmeter or oscilloscope to monitor the current variation.

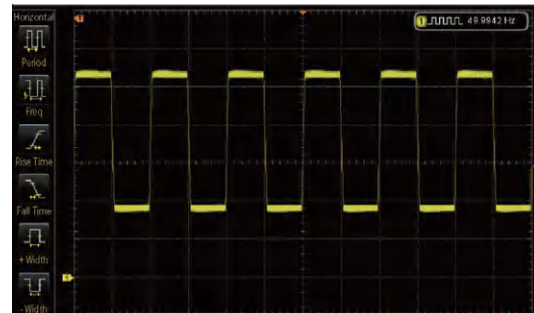

Programmable slew rate

Rise and fall slew rates are settable to prevent overshoot and meet different test demands.

The conversion slew defines the current or voltage transition rate when the on-load main value of N68000 changes. When the slew is set to the maximum value, the transition time between the main value and the transient value is minimal.

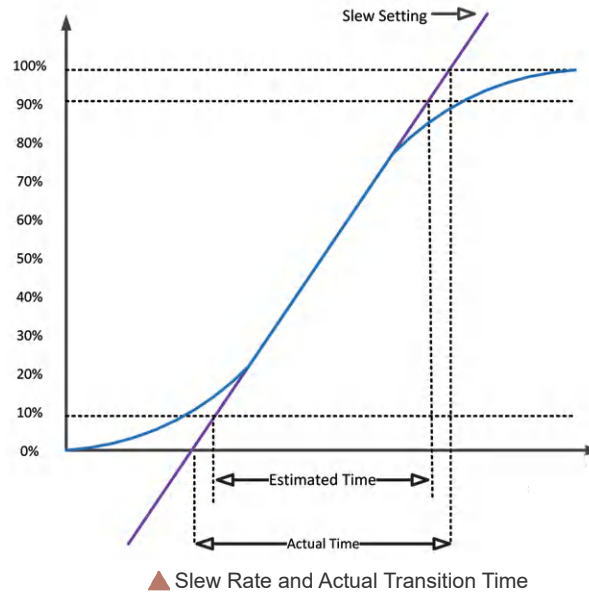

Quick Selection

Model	Specification	Size	Model	Specification	Size
N68024-150-200	2.4kW/150V/200A	19inch/3U	N68084-600-210	8.4kW/600V/210A	19inch/9U
N68024-150-060	2.4kW/150V/60A	19inch/3U	N68084-1000-070	8.4kW/1000V/70A	19inch/9U
N68024-600-020	2.4kW/600V/20A	19inch/3U	N68084-1000-210	8.4kW/1000V/210A	19inch/9U
N68024-600-060	2.4kW/600V/60A	19inch/3U	N68096-150-800	9.6kW/150V/800A	19inch/9U
N68024-1000-020	2.4kW/1000V/20A	19inch/3U	N68096-150-240	9.6kW/150V/240A	19inch/9U
N68024-1000-060	2.4kW/1000V/60A	19inch/3U	N68096-600-080	9.6kW/600V/80A	19inch/9U
N68036-150-300	3.6kW/150V/300A	19inch/3U	N68096-600-240	9.6kW/600V/240A	19inch/9U
N68036-150-090	3.6kW/150V/90A	19inch/3U	N68096-1000-080	9.6kW/1000V/80A	19inch/9U
N68036-600-030	3.6kW/600V/30A	19inch/3U	N68096-1000-240	9.6kW/1000V/240A	19inch/9U
N68036-600-090	3.6kW/600V/90A	19inch/3U	N68108-150-900	10.8kW/150V/900A	19inch/9U
N68036-1000-030	3.6kW/1000V/30A	19inch/3U	N68108-150-270	10.8kW/150V/270A	19inch/9U
N68036-1000-090	3.6kW/1000V/90A	19inch/3U	N68108-600-090	10.8kW/600V/90A	19inch/9U
N68048-150-400	4.8kW/150V/400A	19inch/6U	N68108-600-270	10.8kW/600V/270A	19inch/9U
N68048-150-120	4.8kW/150V/120A	19inch/6U	N68108-1000-090	10.8kW/1000V/90A	19inch/9U
N68048-600-040	4.8kW/600V/40A	19inch/6U	N68108-1000-270	10.8kW/1000V/270A	19inch/9U
N68048-600-120	4.8kW/600V/120A	19inch/6U	N68120-150-1000	12kW/150V/1000A	19inch/12U
N68048-1000-040	4.8kW/1000V/40A	19inch/6U	N68120-150-300	12kW/150V/300A	19inch/12U
N68048-1000-120	4.8kW/1000V/120A	19inch/6U	N68120-600-100	12kW/600V/100A	19inch/12U
N68060-150-500	6kW/150V/500A	19inch/6U	N68120-600-300	12kW/600V/300A	19inch/12U
N68060-150-150	6kW/150V/150A	19inch/6U	N68120-1000-100	12kW/1000V/100A	19inch/12U
N68060-600-050	6kW/600V/50A	19inch/6U	N68120-1000-300	12kW/1000V/300A	19inch/12U
N68060-600-150	6kW/600V/150A	19inch/6U	N68132-150-1100	13.2kW/150V/1100A	19inch/12U
N68060-1000-050	6kW/1000V/50A	19inch/6U	N68132-150-330	13.2kW/150V/330A	19inch/12U
N68060-1000-150	6kW/1000V/150A	19inch/6U	N68132-600-110	13.2kW/600V/110A	19inch/12U
N68072-150-600	7.2kW/150V/600A	19inch/6U	N68132-600-330	13.2kW/600V/330A	19inch/12U
N68072-150-180	7.2kW/150V/180A	19inch/6U	N68132-1000-110	13.2kW/1000V/110A	19inch/12U

Quick Selection

Model	Specification	Size	Model	Specification	Size
N68072-600-060	7.2kW/600V/60A	19inch/6U	N68132-1000-330	13.2kW/1000V/330A	19inch/12U
N68072-600-180	7.2kW/600V/180A	19inch/6U	N68144-150-1200	14.4kW/150V/1200A	19inch/12U
N68072-1000-060	7.2kW/1000V/60A	19inch/6U	N68144-150-360	14.4kW/150V/360A	19inch/12U
N68072-1000-180	7.2kW/1000V/180A	19inch/6U	N68144-600-120	14.4kW/600V/120A	19inch/12U
N68084-150-700	8.4kW/150V/700A	19inch/9U	N68144-600-360	14.4kW/600V/360A	19inch/12U
N68084-150-210	8.4kW/150V/210A	19inch/9U	N68144-1000-120	14.4kW/1000V/120A	19inch/12U
N68084-600-070	8.4kW/600V/70A	19inch/9U	N68144-1000-360	14.4kW/1000V/360A	19inch/12U

Product Dimension

DC Electronic Load

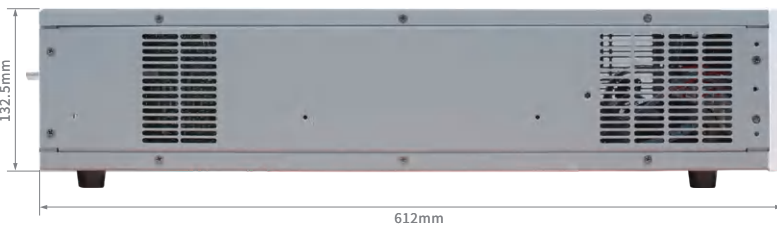
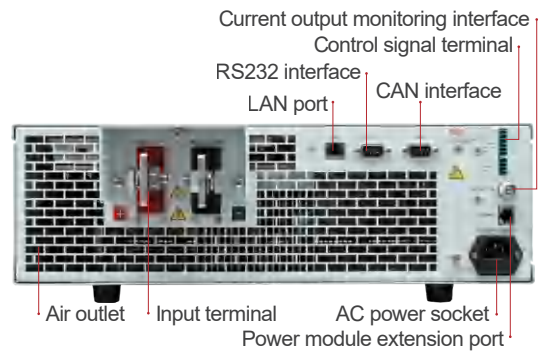
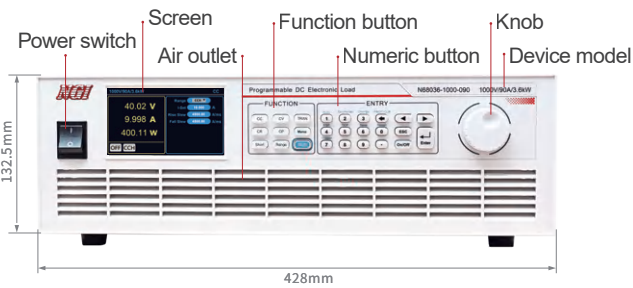

Technical Data Sheet(1)

Model	N68024-150-200		N68024-150-060		N68024-600-020	
Voltage	150V		150V		600V	
Current	200A		60A		20A	
Power	2400W					
Min. Operating Voltage	2V@200A		2V@60A		4.5V@20A	
CC Mode						
Range	0~20A	0~200A	0~6A	0~60A	0~2A	0~20A
Setting Resolution	1mA	10mA	0.1mA	1mA	0.1mA	1mA
Setting Accuracy (23±5°C)	0.05%+0.1%F.S.					
CV Mode						
Range	0~15V	0~150V	0~15V	0~150V	0~60V	0~600V
Setting Resolution	1mV	10mV	1mV	10mV	1mV	10mV
Setting Accuracy (23±5°C)	0.05%+0.05%F.S.					
CP Mode						
Range	0~2400W					
Setting Resolution	0.1W					
Setting Accuracy (23±5°C)	0.5%+1%F.S.					
CR Mode						
Range	0.02Ω~75Ω	0.3Ω~750Ω	0.05Ω~250Ω	1Ω~2500Ω	0.56Ω~3000Ω	11.2Ω~30000Ω
Setting Resolution	16bits					
Setting Accuracy (23±5°C)	0.35%+4.3mS	0.35%+0.43mS	0.35%+1.3mS	0.35%+0.13mS	0.35%+0.1mS	0.35%+0.01mS
Slew Rate						
Current	3.3~200A/ms	200~10000A/ms	1~60A/ms	60~3000A/ms	0.3~20A/ms	20~1000A/ms
Voltage	1.0~50V/ms	50~500V/ms	1.0~50V/ms	50~500V/ms	5.0~250V/ms	250~2500V/ms
Power	3.3~200A/ms	200~10000A/ms	1~60A/ms	60~3000A/ms	0.3~20A/ms	20~1000A/ms
Resistance	3.3~200A/ms	200~10000A/ms	1~60A/ms	60~3000A/ms	0.3~20A/ms	20~1000A/ms
Accuracy (23±5°C)	(1+35%)* Setting value					
Voltage Measurement						
Range	0~15V	0~150V	0~15V	0~150V	0~60V	0~600V
Readback Accuracy (23±5°C)	0.05%+0.05%F.S.					
Current Measurement						
Range	0~20A	0~200A	0~6A	0~60A	0~2A	0~20A
Readback Accuracy (23±5°C)	0.05%+0.1%F.S.					
Power Measurement						
Range	0~2400W					
Readback Accuracy (23±5°C)	0.5%+1%F.S.					
Dynamic Mode						
T1&T2	0.015~60000ms					
Resolution	1μs/1ms					
Accuracy (23±5°C)	≤20μs+100ppm					
Others						
Interface	LAN/RS232/CAN					
AC Input	Single phase, 220V AC±10%, frequency 47Hz~63Hz					
Communication Response Time	≤10ms					
Temperature	Operating temperature: 0°C~40°C, storage temperature: -20°C~60°C					
Operating Environment	Altitude <2000m, relative humidity: 5%~90%RH(non-condensing), atmospheric pressure: 80~110kPa					
Net Weight	Approx. 23.5kg					
Dimension	3U, 132.5(H)*482.0(W)with handle*612.0(D) mm					

Note 1: For other specifications, please contact NGI.

Note 2: All specifications are subject to change without notice.

Technical Data Sheet(2)

Model	N68024-600-060		N68024-1000-020		N68024-1000-060	
Voltage	600V		1000V		1000V	
Current	60A		20A		60A	
Power	2400W					
Min. Operating Voltage	4.5V@60A		5V@20A		20V@60A	
CC Mode						
Range	0~6A	0~60A	0~2A	0~20A	0~6A	0~60A
Setting Resolution	0.1mA	1mA	0.1mA	1mA	0.1mA	1mA
Setting Accuracy (23±5°C)	0.05%+0.1%F.S.					
CV Mode						
Range	0~60V	0~600V	0~100V	0~1000V	0~100V	0~1000V
Setting Resolution	1mV	10mV	10mV	100mV	10mV	100mV
Setting Accuracy (23±5°C)	0.05%+0.05%F.S.					
CP Mode						
Range	0~2400W					
Setting Resolution	0.1W					
Setting Accuracy (23±5°C)	0.5%+1%F.S.					
CR Mode						
Range	0.19Ω~1000Ω	3.8Ω~10000Ω	0.93Ω~5000Ω	18.6Ω~50000Ω	0.31Ω~1666.6Ω	6.2Ω~16666Ω
Setting Resolution	16bits					
Setting Accuracy (23±5°C)	0.35%+0.3mS	0.35%+0.03mS	0.35%+0.1mS	0.35%+0.01mS	0.35%+0.2mS	0.35%+0.02mS
Slew Rate						
Current	1~60A/ms	60~3000A/ms	0.3~20A/ms	20~1000A/ms	1~60A/ms	60~3000A/ms
Voltage	5.0~250V/ms	250~2500V/ms	8.0~400V/ms	400~4000V/ms	8.0~400V/ms	400~4000V/ms
Power	1~60A/ms	60~3000A/ms	0.3~20A/ms	20~1000A/ms	1~60A/ms	60~3000A/ms
Resistance	1~60A/ms	60~3000A/ms	0.3~20A/ms	20~1000A/ms	1~60A/ms	60~3000A/ms
Accuracy (23±5°C)	(1+35%)* Setting value					
Voltage Measurement						
Range	0~60V	0~600V	0~100V	0~1000V	0~100V	0~1000V
Readback Accuracy(23±5°C)	0.05%+0.05%F.S.					
Current Measurement						
Range	0~6A	0~60A	0~2A	0~20A	0~6A	0~60A
Readback Accuracy(23±5°C)	0.05%+0.1%F.S.					
Power Measurement						
Range	0~2400W					
Readback Accuracy(23±5°C)	0.5%+1%F.S.					
Dynamic Mode						
T1&T2	0.015~60000ms					
Resolution	1μs/1ms					
Accuracy (23±5°C)	≤20μs+100ppm					
Others						
Interface	LAN/RS232/CAN					
AC Input	Single phase, 220V AC±10%, frequency 47Hz~63Hz					
Communication Response Time	≤10ms					
Temperature	Operating temperature: 0°C~40°C, storage temperature: -20°C~60°C					
Operating Environment	Altitude <2000m, relative humidity: 5%~90%RH(non-condensing), atmospheric pressure: 80~110kPa					
Net Weight	Approx. 23.5kg					
Dimension	3U, 132.5(H)*482.0(W)with handle*612.0(D) mm					

Note 1: For other specifications, please contact NGI.

Note 2: All specifications are subject to change without notice.

Technical Data Sheet(3)

Model	N68036-150-300		N68036-150-090		N68036-600-030	
Voltage	150V		150V		600V	
Current	300A		90A		30A	
Power	3600W					
Min. Operating Voltage	2V@300A		2V@90A		4.5V@30A	
CC Mode						
Range	0~30A	0~300A	0~9A	0~90A	0~3A	0~30A
Setting Resolution	1mA	10mA	0.1mA	1mA	0.1mA	1mA
Setting Accuracy (23±5°C)	0.05%+0.1%F.S.					
CV Mode						
Range	0~15V	0~150V	0~15V	0~150V	0~60V	0~600V
Setting Resolution	1mV	10mV	1mV	10mV	1mV	10mV
Setting Accuracy (23±5°C)	0.05%+0.05%F.S.					
CP Mode						
Range	0~3600W					
Setting Resolution	0.1W					
Setting Accuracy (23±5°C)	0.5%+1%F.S.					
CR Mode						
Range	0.01Ω~50Ω	0.2Ω~500Ω	0.04Ω~166.6Ω	0.7Ω~1666Ω	0.38Ω~2000Ω	7.5Ω~20000Ω
Setting Resolution	16bits					
Setting Accuracy (23±5°C)	0.35%+6.4mS	0.35%+0.64mS	0.35%+1.9mS	0.35%+0.19mS	0.35%+0.2mS	0.35%+0.02mS
Slew Rate						
Current	5~300A/ms	300~15000A/ms	1.5~90A/ms	90~4500A/ms	0.5~30A/ms	30~1500A/ms
Voltage	1.0~50V/ms	50~500V/ms	1.0~50V/ms	50~500V/ms	5.0~250V/ms	250~2500V/ms
Power	5~300A/ms	300~15000A/ms	1.5~90A/ms	90~4500A/ms	0.5~30A/ms	30~1500A/ms
Resistance	5~300A/ms	300~15000A/ms	1.5~90A/ms	90~4500A/ms	0.5~30A/ms	30~1500A/ms
Accuracy (23±5°C)	(1+35%)* Setting value					
Voltage Measurement						
Range	0~15V	0~150V	0~15V	0~150V	0~60V	0~600V
Readback Accuracy(23±5°C)	0.05%+0.05%F.S.					
Current Measurement						
Range	0~30A	0~300A	0~9A	0~90A	0~3A	0~30A
Readback Accuracy(23±5°C)	0.05%+0.1%F.S.					
Power Measurement						
Range	0~3600W					
Readback Accuracy(23±5°C)	0.5%+1%F.S.					
Dynamic Mode						
T1&T2	0.015~60000ms					
Resolution	1μs/1ms					
Accuracy (23±5°C)	≤20μs+100ppm					
Others						
Interface	LAN/RS232/CAN					
AC Input	Single phase, 220V AC±10%, frequency 47Hz~63Hz					
Communication Response Time	≤10ms					
Temperature	Operating temperature: 0°C~40°C, storage temperature: -20°C~60°C					
Operating Environment	Altitude <2000m, relative humidity: 5%~90%RH(non-condensing), atmospheric pressure: 80~110kPa					
Net Weight	Approx. 27kg					
Dimension	3U, 132.5(H)*482.0(W)with handle*612.0(D) mm					

Note 1: For other specifications, please contact NGI.

Note 2: All specifications are subject to change without notice.

Technical Data Sheet(4)

Model	N68036-600-090		N68036-1000-030		N68036-1000-090	
Voltage	600V		1000V		1000V	
Current	90A		30A		90A	
Power	3600W					
Min. Operating Voltage	4.5V@90A		5V@30A		20V@90A	
CC Mode						
Range	0~9A	0~90A	0~3A	0~30A	0~9A	0~90A
Setting Resolution	0.1mA	1mA	0.1mA	1mA	0.1mA	1mA
Setting Accuracy (23±5°C)	0.05%+0.1%F.S.					
CV Mode						
Range	0~60V	0~600V	0~100V	0~1000V	0~100V	0~1000V
Setting Resolution	1mV	10mV	10mV	100mV	10mV	100mV
Setting Accuracy (23±5°C)	0.05%+0.05%F.S.					
CP Mode						
Range	0~3600W					
Setting Resolution	0.1W					
Setting Accuracy (23±5°C)	0.5%+1%F.S.					
CR Mode						
Range	0.13Ω~666.6Ω	2.5Ω~6666Ω	0.62Ω~3333.3Ω	12.4Ω~33333Ω	0.21Ω~1111.1Ω	4.2Ω~11111Ω
Setting Resolution	16bits					
Setting Accuracy (23±5°C)	0.35%+0.5mS	0.35%+0.05mS	0.35%+0.1mS	0.35%+0.01mS	0.35%+0.3mS	0.35%+0.03mS
Slew Rate						
Current	1.5~90A/ms	90~4500A/ms	0.5~30A/ms	30~1500A/ms	1.5~90A/ms	90~4500A/ms
Voltage	5.0~250V/ms	250~2500V/ms	8.0~400V/ms	400~4000V/ms	8.0~400V/ms	400~4000V/ms
Power	1.5~90A/ms	90~4500A/ms	0.5~30A/ms	30~1500A/ms	1.5~90A/ms	90~4500A/ms
Resistance	1.5~90A/ms	90~4500A/ms	0.5~30A/ms	30~1500A/ms	1.5~90A/ms	90~4500A/ms
Accuracy (23±5°C)	(1+35%)* Setting value					
Voltage Measurement						
Range	0~60V	0~600V	0~100V	0~1000V	0~100V	0~1000V
Readback Accuracy(23±5°C)	0.05%+0.05%F.S.					
Current Measurement						
Range	0~9A	0~90A	0~3A	0~30A	0~9A	0~90A
Readback Accuracy(23±5°C)	0.05%+0.1%F.S.					
Power Measurement						
Range	0~3600W					
Readback Accuracy(23±5°C)	0.5%+1%F.S.					
Dynamic Mode						
T1&T2	0.015~60000ms					
Resolution	1μs/1ms					
Accuracy (23±5°C)	≤20μs+100ppm					
Others						
Interface	LAN/RS232/CAN					
AC Input	Single phase, 220V AC±10%, frequency 47Hz~63Hz					
Communication Response Time	≤10ms					
Temperature	Operating temperature: 0°C~40°C, storage temperature: -20°C~60°C					
Operating Environment	Altitude <2000m, relative humidity: 5%~90%RH(non-condensing), atmospheric pressure: 80~110kPa					
Net Weight	Approx. 27kg					
Dimension	3U, 132.5(H)*482.0(W)with handle*612.0(D) mm					

Note 1: For other specifications, please contact NGI.

Note 2: All specifications are subject to change without notice.